



F5® Device Cryptographic Module

FIPS 140-2 Non-Proprietary Security Policy

Hardware Versions:

**BIG-IP i4000, BIG-IP i5000, BIG-IP i5820-DF, BIG-IP i7000,
BIG-IP i7820-DF, BIG-IP i10800, BIG-IP i11800-DS, BIG-IP i15800,
BIG-IP 5250v-F, BIG-IP 7200v-F, BIG-IP 10200v-F, BIG-IP 10350v-F,
VIPRION B2250 and VIPRION B4450**

Firmware Version:

14.1.0.3 EHF

FIPS Security Level 2

document version 1.3

Document Revision: June 2022

Prepared by:
atsec information security corporation
9130 Jollyville Road, Suite 260
Austin, TX 78759
www.atsec.com

Table of Contents

1	Cryptographic Module Specification	6
1.1	Module Description	6
1.2	FIPS 140-2 Validation Level.....	8
1.3	Description of modes of operation.....	9
1.4	Cryptographic Module Boundary.....	12
2	Cryptographic Module Ports and Interfaces	14
3	Roles, Services and Authentication	18
3.1	Roles.....	18
3.2	Authentication	19
3.3	Services	20
4	Physical Security	25
4.1	Tamper Label Placement	25
5	Operational Environment	31
6	Cryptographic Key Management	32
6.1	Key Generation	32
6.2	Key Establishment	32
6.3	Key Entry / Output	33
6.4	Key / CSP Storage	33
6.5	Key / CSP Zeroization.....	33
6.6	Random Number Generation	34
7	Self-Tests	35
7.1	Power-Up Tests	35
7.1.1	Integrity Tests	35
7.1.2	Cryptographic algorithm tests.....	35
7.2	On-Demand self-tests	36
7.3	Conditional Tests	36
8	Guidance	38
8.1	Delivery and Operation.....	38
8.2	Crypto Officer Guidance.....	38
8.2.1	Installing Tamper Evident Labels	38
8.2.2	Install Device.....	38
8.2.3	Password Strength Requirement.....	39
8.2.4	Additional Guidance	39
8.2.5	Version Configuration.....	39
8.3	User Guidance	40

9 Mitigation of Other Attacks41

Figure 1 – Hardware Block Diagram..... 13

Figure 2 – BIG-IP i4000..... 14

Figure 3 – BIG-IP i5000 / i5820-DF 15

Figure 4 – BIG-IP i7000 / i7820-DF 15

Figure 5 – BIG-IP i10800 / i11800-DS 15

Figure 6 – BIG-IP i15800..... 15

Figure 7 – BIG-IP 5250v-F..... 16

Figure 8 – BIG-IP 7200v-F..... 16

Figure 9 – BIG-IP 10200v-F..... 16

Figure 10 – BIG-IP 10350v-F..... 16

Figure 11 – VIPRION B2250 17

Figure 12 – VIPRION B4450 17

Figure 13 – BIG-IP i4000 (3 of 3 tamper labels)..... 26

Figure 14 – BIG-IP i5000 (3 of 3 tamper labels)..... 26

Figure 15 – BIG-IP i5820-DF (4 tamper labels shown) 26

Figure 16 – BIG-IP i7000 (6 of 6 tamper labels shown) 26

Figure 17 – BIG-IP i7820-DF (4 tamper labels shown) 27

Figure 18 – BIG-IP i10800 / i11800-DS (6 tamper labels shown) 27

Figure 19 – BIG-IP i10800 / i11800-DS (tamper label 5 & 6) 27

Figure 20 – BIG-IP i15800 (Front tamper labels 1-3 labels shown)..... 28

Figure 21 – BIG-IP i15800 (Back tamper labels 4 and 5 labels shown)..... 28

Figure 22 – BIG-IP 5250v-F (4 tamper labels shown) 28

Figure 23 – BIG-IP 7200v-F (5 tamper labels shown) 28

Figure 24 – BIG-IP 10200v-F (Front tamper labels 1-3 shown) 29

Figure 25 – BIG-IP 10200v-F (Back tamper label 4 shown) 29

Figure 26 – VIPRION B2250 in chassis (1 of 6 tamper labels shown) 29

Figure 27 – VIPRION B2250 top view (5 of 6 tamper labels shown) 29

Figure 28 – VIPRION B4450 in chassis..... 29

Figure 29 – VIPRION B4450 front (1 of 5 tamper labels shown) 29

Figure 30 – VIPRION B4450 top-view (4 of 5 tamper labels shown) 30

Table 1 – Tested Modules..... 8

Table 2 – Security Levels 9

Table 3 - Approved Cryptographic Algorithms..... 11

Table 4 - Non-Approved but Allowed in FIPS mode Cryptographic Algorithms 11

Table 5 - Non-Approved and Non-Compliant Cryptographic Algorithms/Modes..... 12

Table 6 - Ports and Interfaces..... 14

Table 7 - FIPS 140-2 Roles 19

Table 8 - Authentication of Roles..... 19

Table 9 - Non-Authenticated Services 20

Table 10 - Management Services 22

Table 11 - Crypto Services in FIPS mode of operation 23

Table 12 - Services in non-FIPS mode of operation 24

Table 13 - Inspection of Tamper Evident Labels 25

Table 14 - Number of Tamper Evident Labels per hardware appliance 25

Table 15 - Life cycle of CSPs..... 32

Table 16 - Self-Tests 36

Table 17 - Conditional Tests 37

Copyrights and Trademarks

F5® and BIG-IP® are registered trademarks of F5. Inc..
 Intel® and Xeon® are registered trademarks of Intel® Corporation.

Introduction

This document is the non-proprietary FIPS 140-2 Security Policy of F5® Device Cryptographic Module with firmware version 14.1.0.3 EHF and hardware version listed in table 1. It contains the security rules under which the module must operate and describes how this module meets the requirements as specified in FIPS PUB 140-2 (Federal Information Processing Standards Publication 140-2) for a Security Level 2 module.

1 Cryptographic Module Specification

The following section describes the cryptographic module and how it conforms to the FIPS 140-2 specification in each of the required areas.

1.1 Module Description

The F5® Device Cryptographic Module (hereafter referred to as “the module”) is a smart evolution of Application Delivery Controller (ADC) technology. Solutions built on this platform are load balancers. They are full proxies that give visibility into, and the power to control—inspect and encrypt or decrypt—all the traffic that passes through your network.

Underlying all BIG-IP hardware and software is F5’s proprietary operating system, TMOS, which provides unified intelligence, flexibility, and programmability. With its application control plane architecture, TMOS gives you control over the acceleration, security, and availability services your applications require. TMOS establishes a virtual, unified pool of highly scalable, resilient, and reusable services that can dynamically adapt to the changing conditions in data centers and virtual and cloud infrastructures.

The module has been tested on the following multichip standalone devices with the firmware version 14.1.0.3 EHF.

Hardware	Processor ¹	Operating System	Specifications ²
BIG-IP i4000	Intel® Xeon® D	TMOS 14.1.0.3 EHF	<ul style="list-style-type: none"> • 1 x USB port • 8 x 1GbE; 4 x 10GbE network ports • 1 x Console port • 1 x 1GbE management port • 4 x LEDs
BIG-IP i5000	Intel® Xeon® E5	TMOS 14.1.0.3 EHF	<ul style="list-style-type: none"> • 1 x USB port • 8 x 1GbE; 4 x 40GbE network ports • 1 x Console port • 1 x GbE management port • 4 x LEDs
BIG-IP i5820-DF	Intel® Xeon® E5	TMOS 14.1.0.3 EHF	<ul style="list-style-type: none"> • 1 x USB port • 8 x 10GbE; 4 x 40GbE network ports • 1 x Console port • 1 x 1GbE management port • 4 x LEDs

¹ The modules make use of the AES-NI instruction provided by the underlying processor.

² The USB port found on all platforms are specified as used only for exporting of audit logs.

Hardware	Processor ¹	Operating System	Specifications ²
BIG-IP i7000	Intel® Xeon® E5	TMOS 14.1.0.3 EHF	<ul style="list-style-type: none"> • 1 x USB port • 8 x 1GbE; 6 x 10GbE network ports • 1 x Console port • 1 x 1GbE management port • 4 x LEDs
BIG-IP i7820-DF	Intel® Xeon® E5	TMOS 14.1.0.3 EHF	<ul style="list-style-type: none"> • 1 x USB port • 8 x 10GbE; 4 x 40GbE network ports • 1 x Console port • 1 x 1GbE management port • 4 x LEDs
BIG-IP i10800	Intel® Xeon® E5	TMOS 14.1.0.3 EHF	<ul style="list-style-type: none"> • 1 x USB port • 8 x 10GbE; 6 x 40GbE network ports • 1 x Console port • 1 x 1GbE management port • 4 x LEDs
BIG-IP i11800-DS	Intel® Xeon® E5	TMOS 14.1.0.3 EHF	<ul style="list-style-type: none"> • 1 x USB port • 8 x 10GbE; 6 x 40GbE network ports • 1 x Console port • 1 x 1GbE management port • 4 x LEDs
BIG-IP i15800	Intel® Xeon® E5	TMOS 14.1.0.3 EHF	<ul style="list-style-type: none"> • 1 x USB port • 8 x 40GbE; 4 x 100GbE network ports • 1 x Console port • 1 x 1GbE management port • 4 x LEDs
BIG-IP 5250v-F	Intel® Xeon® E3	TMOS 14.1.0.3 EHF	<ul style="list-style-type: none"> • 2 x USB port • 4 x 1GbE; 8 x 10GbE network ports • 1 x Console port • 1 x GbE management port • 4 x LEDs
BIG-IP 7200v-F	Intel® Xeon® E3	TMOS 14.1.0.3 EHF	<ul style="list-style-type: none"> • 2 x USB port • 4 x 1GbE; 8 x 10GbE network ports • 1 x Console port • 1 x GbE management port • 4 x LEDs

Hardware	Processor ¹	Operating System	Specifications ²
BIG-IP 10200v-F	Intel® Xeon® E5	TMOS 14.1.0.3 EHF	<ul style="list-style-type: none"> • 1 x USB port • 16 x 10GbE; 2 x 40GbE network ports • 1 x Console port • 1 x GbE management port • 4 x LEDs
BIG-IP 10350v-F	Intel® Xeon® E5	TMOS 14.1.0.3 EHF	<ul style="list-style-type: none"> • 1 x USB port • 16 x 10GbE; 2 x 40GbE network ports • 1 x Console port • 1 x GbE management port • 4 x LEDs
VIPRION B2250	Intel® Xeon® E5	TMOS 14.1.0.3 EHF	<ul style="list-style-type: none"> • 1 x USB port • 4 x 40 GbE network ports • 1 x Console port • 1 x GbE management port • 4 x LEDs
VIPRION B4450	Intel® Xeon® E5	TMOS 14.1.0.3 EHF	<ul style="list-style-type: none"> • 1 x USB port • 4 x 40 GbE; 2 x 100 GbE network ports • 1 x Console port • 1 x GbE management port • 4 x LEDs

Table 1 - Tested Modules

1.2 FIPS 140-2 Validation Level

For the purpose of the FIPS 140-2 validation, the F5® Device Cryptographic Module is defined as a multi-chip standalone hardware cryptographic module validated at overall security level 2. The table below shows the security level claimed for each of the eleven sections that comprise the FIPS 140-2 standard:

FIPS 140-2 Section		Security Level
1	Cryptographic Module Specification	2
2	Cryptographic Module Ports and Interfaces	2
3	Roles, Services and Authentication	2
4	Finite State Model	2
5	Physical Security	2
6	Operational Environment	N/A
7	Cryptographic Key Management	2
8	EMI/EMC	2
9	Self-Tests	2
10	Design Assurance	2
11	Mitigation of Other Attacks	N/A
Overall Level		2

Table 2 - Security Levels

1.3 Description of modes of operation

The module must be installed in the FIPS validated configuration as stated in Section 8 – Guidance. In the operation mode the module supports two modes of operation:

- in "FIPS mode" (the FIPS Approved mode of operation) only approved or allowed security functions with sufficient security strength can be used.
- in "non-FIPS mode" (the non-Approved mode of operation) only non-approved security functions can be used.

The module enters operational mode after power-up tests succeed. Once the module is operational, the mode of operation is implicitly assumed depending on the security function invoked and the security strength of the cryptographic keys. Critical Security Parameters (CSPs) used or stored in FIPS mode are not used in non-FIPS mode, and vice versa.

In the FIPS Approved Mode, the cryptographic module will provide the following CAVP certified cryptographic algorithms. Here the Control, or Management, plane refers to the connection from an administrator to the BIG-IP for system management. The Data Plane refers to the traffic passed between external entities and internal servers

Algorithm	Usage	Keys/CSPs	Certificate Number	
			Control Plane ³	Data Plane ⁴
AES-ECB AES-CBC AES-GCM ⁵	Encryption and Decryption	128/192/256-bit AES key	C701	N/A
AES-CBC AES-GCM ⁵		128/256-bit AES key	N/A	C699, C700
SP800-90A CTR_DRBG	Random Number Generation	Entropy input string, V and Key values	C701	C699, C700
FIPS 186-4 RSA Key Pair Generation	RSA Key Generation	RSA public and private keys with 2048/3072-bit modulus size	C701	N/A
PKCS#1 v1.5 RSA Signature Generation with SHA-256 and SHA-384 and Signature Verification with SHA-1, SHA-256 and SHA-384	RSA Signature Generation and Verification	RSA private key with 2048/3072-bit modulus	C701	C699, C700
FIPS 186-4 ECC Key Pair Generation (Appendix B.4.2)	ECDSA Key Pair Generation	ECDSA public/private keys for P-256 and P-384 curves	C701	C699, C700
FIPS 186-4 ECDSA Signature Generation and Signature Verification	ECDSA Signature Generation and Verification	ECDSA private key (P-256 P- 384 curves)	C701	C699, C700
SHA-1 SHA-256 SHA-384	Message Digest	N/A	C701	C699, C700

³ For control plane, the platforms BIG-IP i4000, BIG-IP i5000, BIG-IP i5820-DF, BIG-IP i7000, BIG-IP i7820-DF, BIG-IP i10800, BIG-IP i11800-DS, BIG-IP i15800, BIG-IP 5250v-F, BIG-IP 7200v-F, BIG-IP 10200v-F, BIG-IP 10350v-F, VIPRION B2250, VIPRION B4450 with processors D, E3 and E5 share the same CAVP certificate

⁴ For data plane, the platforms BIG-IP i11800-DS, BIG-IP 5250v-F, BIG-IP 7200v-F, BIG-IP 10200v-F, BIG-IP 10350v-F and VIPRION B2250 with E3 and E5 processors share the same CAVP certificate. The platforms BIG-IP i4000, BIG-IP i10800, BIG-IP i5000, BIG-IP i5820-DF, BIG-IP i7000, BIG-IP i7820-DF, BIG-IP i15800 and VIPRION B4450, with D and E5 processors share the same CAVP certificate.

⁵ Not all algorithms/modes tested are used within the module.

HMAC-SHA-1 HMAC-SHA-256 HMAC-SHA-384	Message Authentication	HMAC key (>=112-bit)	C701	C699, C700
TLS ⁶ 1.0/1.1/1.2 with SHA-256 and SHA-384			C701	C699, C700

Table 3 - Approved Cryptographic Algorithms

The following table lists the non-Approved algorithms that are allowed in FIPS approved mode along with their usage:

Algorithm	Usage	Keys/CSPs	Certificate Number	
			Control Plane	Data Plane
PKCS#1 v1.5 RSA Key Wrapping	Asymmetric Encryption and Decryption	RSA key pair	Non-Approved but Allowed	Non-Approved but Allowed
NDRNG	Seeding DRBG	seed	Non-Approved but Allowed	Non-Approved but Allowed

Table 4 - Non-Approved but Allowed in FIPS mode Cryptographic Algorithms

The following table lists the non-FIPS Approved algorithms along with their usage:

Algorithm	Usage	Notes
AES	Symmetric Encryption and Decryption	using OFB, CFB, CTR, XTS ⁷ and KW modes
DES RC4 Triple-DES SM2/ SM4		n/a
RSA	Asymmetric Encryption and Decryption	using modulus sizes less than 2048-bits or greater than 3072 bits
RSA	Asymmetric Key Generation	FIPS 186-4 less than 2048-bit modulus size or greater than 3072 bits
DSA		using any key size
ECDH		using key pair for all P-curves, in Control Plane implementation.
ECDSA		using public/private key pair for curves other than P-256 and P-384.

⁶ No parts of the TLS protocol except the KDF has been reviewed or tested by the CAVP and CMVP

⁷ The AES-XTS mode shall only be used for the cryptographic protection of data on storage devices. The AES-XTS shall not be used for other purposes, such as the encryption of data in transit.

RSA	Digital Signature Generation and Verification	PKCS#1 v1.5 using key sizes other than 2048 and 3072 bits
		PKCS#1 v1.5 using SHA-1, SHA-224 and SHA-512 and 2048/3072-bit key sizes Used in the SSH protocol Used in the TLS protocol with DH/ECDH key exchange
		using X9.31 standard
		using Probabilistic Signature Scheme (PSS)
DSA		using any key size and SHA variant
ECDSA		FIPS 186-4 using curves other than P-256 and P-384
		FIPS 186-4 using curves P-256 and P-384 with SHA-1, SHA-224 and SHA-512
SHA-224/ SHA-512 MD5 SM3	Message Digest	N/A
HMAC-SHA-224 HMAC-SHA-512 AES-CMAC Triple-DES-CMAC	Message Authentication	N/A
Diffie-Hellman	Key Agreement Scheme	N/A
ECDH		ECDH shared secret computation using all P-curves
TLS KDF	Key Derivation function	Using SHA-1/SHA-224/SHA-512
SSH KDF		using any SHA variant
SNMP KDF		using any SHA variant
IKEv1 and IKEv2 KDF		

Table 5 - Non-Approved and Non-Compliant Cryptographic Algorithms/Modes

1.4 Cryptographic Module Boundary

The cryptographic boundary of the module is defined by the exterior surface of the appliance (red dotted line). The block diagram below shows the module, the flow of status output (SO), control input (CI), data input (DI) and data output (DO), the module interfaces with the operational environment and the delimitation of its logical boundary. The Description of the ports and interfaces can be found in *Table - Ports and Interfaces* below.

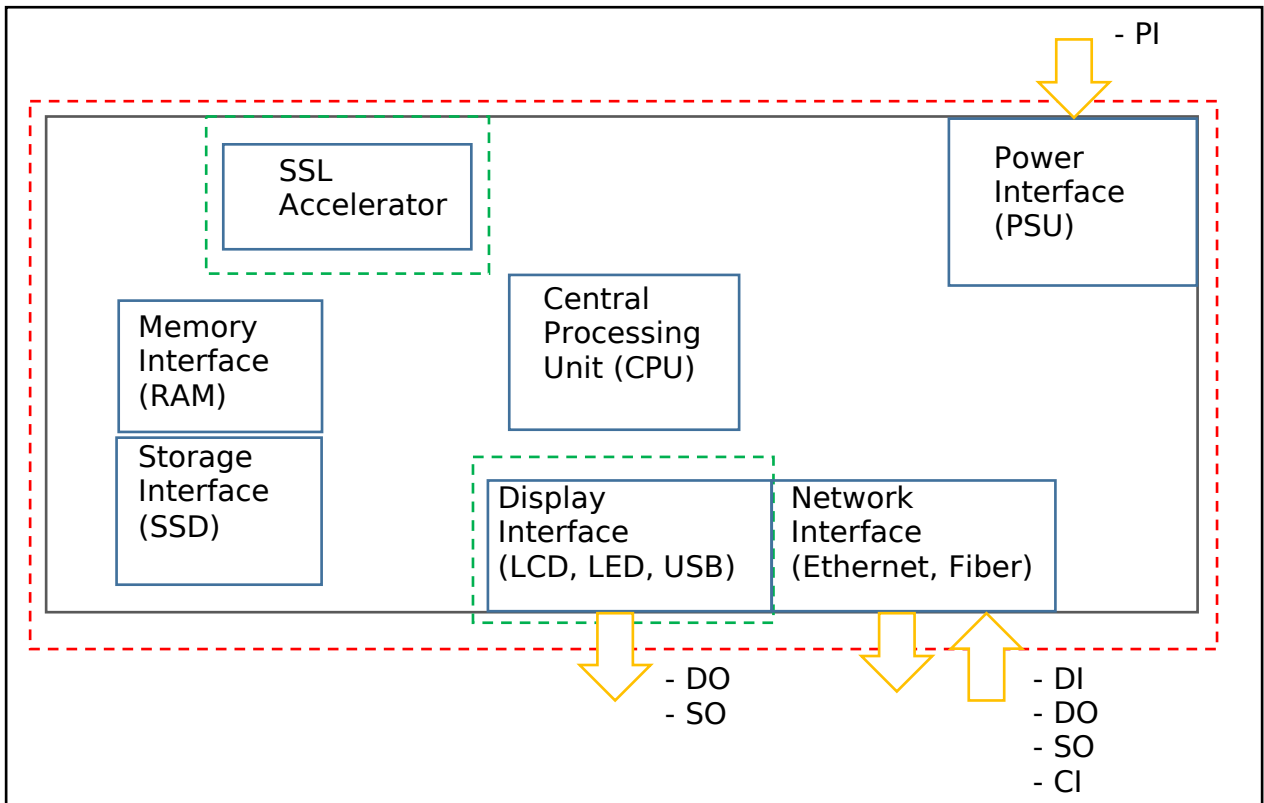

Figure 1 - Hardware Block Diagram

2 Cryptographic Module Ports and Interfaces

For the purpose of the FIPS 140-2 validation, the physical ports are interpreted to be the physical ports of the hardware platform on which it runs.

The logical interfaces are the commands through which users of the module request services. The following table summarizes the four physical interfaces with details of the FIPS 140-2 logical interfaces they correspond to:

Logical Interface	Physical Interface	Description
Data Input	<ul style="list-style-type: none"> Network Interface 	Depending on module, the network interface consists of SFP, SFP+, and/or QSFP+ ports (Ethernet and/or Fiber Optic) which allow transfer speeds from 1Gbps to up to 100Gbps.
Data Output	<ul style="list-style-type: none"> Network Interface Display Interface 	Depending on module, the network interface consists of SFP, SFP+, and/or QSFP+ ports (Ethernet and/or Fiber Optic) which allow transfer speeds from 1Gbps to up to 100Gbps. In addition, Status logs may be output to USB found in the interface.
Control Input	<ul style="list-style-type: none"> Display Interface Network Interface 	The control input found in the display interface includes the power button and reset button. The control input found in the network interface includes the API which control system state (e.g. reset system, power-off system).
Status Output	<ul style="list-style-type: none"> Display Interface 	Depending on model, the display interface can consist of a LCD display, LEDs, and/or output to STDOUT which provides system status information.
Power Input	<ul style="list-style-type: none"> Power Interface 	Removable PSU (x2)

Table 6 - Ports and Interfaces

The pictures below show the various modules that were tested. Please use the images to familiarize yourself with the devices.



Figure 2 - BIG-IP i4000



Figure 3 - BIG-IP i5000 / i5820-DF



Figure 4 - BIG-IP i7000 / i7820-DF



Figure 5 - BIG-IP i10800 / i11800-DS



Figure 6 - BIG-IP i15800



Figure 7 - BIG-IP 5250v-F



Figure 8 - BIG-IP 7200v-F



Figure 9 - BIG-IP 10200v-F



Figure 10 - BIG-IP 10350v-F



Figure 11 - VIPRION B2250



Figure 12 - VIPRION B4450

3 Roles, Services and Authentication

3.1 Roles

The module supports roles-based authentication and the following FIPS 140-2 roles defined:

- **User role:** Performs cryptographic services (in both FIPS mode and non-FIPS mode), key zeroization, module status requests, and on-demand self-tests. The FIPS140-2 role of User is mapped to multiple BIG-IP roles which are responsible for different components of the system (e.g. auditing, certificate management, user management, etc.). The user can access the module through Web Interface described below.
- **Crypto Officer (CO) role:** Crypto officer is represented by the administrator of the BIG-IP. This entity performs module installation and initialization. This role has full access to the system and has the ability to create, delete, and manage other user roles on the system.

The module supports concurrent operators belonging to different roles: one CO and one User role, which creates two different authenticated sessions, achieving the separation between the concurrent operators.

- **One interface can be used to access the module: Web Interface:** The Web interface consists of HTTPS over TLS interface which provides a graphical interface for system management tools. The web interface can be accessed from a TLS-enabled web browser.
- **Note:** The module does not maintain authenticated sessions upon power cycling. Power-cycling the system requires the authentication credentials to be re-entered. Authentication data is protected against unauthorized disclosure, modification and substitution by the Operating System. Additionally, when entering authentication data through the Web interface, any character entered will be obfuscated (i.e. replace the character entered with a dot on the entry box).

FIPS 140-2 Role	BIG-IP Role	Purpose of Role
Crypto Officer	Administrator	Main administrator of the of the BIG-IP system. This role has complete access to all objects on the system. Entities with this role cannot have other roles on the system.
User	Auditor	Entity who can view all configuration data on the system, including logs and archives.
	Certificate Manager	Entity who manages digital certificates and keys.
	Firewall Manager	Grants a user permission to manage all firewall rules and supporting objects. Notably, the Firewall Manager role has no permission to create, update, or delete non-network firewall configurations, including Application Security or Protocol Security policies.
	iRule Manager	Grants a user permission to create, modify, view, and delete iRules. Users with this role cannot affect the way that an iRule is deployed.

FIPS 140-2 Role	BIG-IP Role	Purpose of Role
	Operator	Grants a user permission to enable or disable nodes and pool members. When granted terminal access.
	Resource Manager	Grants a user access to all objects on the system except BIG-IP user accounts. With respect to user accounts, a user with this role can view a list of all user accounts on the system but cannot view or change user account properties except for their own user account. Users with this role cannot have other user roles on the system.
	User Manager	Entity who manages BIG-IP crypto officer accounts.

Table 7 - FIPS 140-2 Roles

3.2 Authentication

FIPS 140-2 Role	Authentication type and data	Strength of Authentication (Single-Attempt)	Strength of Authentication (Multiple-Attempt)
Crypto Officer	Password based (Web Interface)	<p>The password must consist of minimum of 6 characters with at least one from each of the three-character classes. Character classes are defined as: digits (0-9), ASCII lowercase letters (a-z), ASCII uppercase letters (A-Z)</p> <p>Assuming a worst-case scenario where the password contains four digits, one ASCII lowercase letter and one ASCII uppercase letter. The probability to guess every character successfully is $(1/10)^4 * (1/26)^1 * (1/26)^1 = 1/6,760,000$ which is much smaller than 1/1,000,000.</p>	<p>The maximum number of login attempts is limited to 6 after which the account is locked. This means that at worst case an attacker has the probability of guessing the password in one minute as 6/6,760,000 which is less than the requirement of 1/100,000.</p>
User	Password based (Web Interface)	<p>The password must consist of minimum of 6 characters with at least one from each of the three-character classes. Character classes are defined as: digits (0-9), ASCII lowercase letters (a-z), ASCII uppercase letters (A-Z)</p> <p>Assuming a worst-case scenario where the password contains four digits, one ASCII lowercase letter and one ASCII uppercase letter. The probability to guess every character successfully is $(1/10)^4 * (1/26)^1 * (1/26)^1 = 1/6,760,000$ which is much smaller than 1/1,000,000.</p>	<p>The maximum number of login attempts is limited to 6 after which the account is locked. This means that at worst case an attacker has the probability of guessing the password in one minute as 6/6,760,000 which is less than the requirement of 1/100,000.</p>

Table 8 - Authentication of Roles

3.3 Services

The module provides services to users that assume one of the available roles. All services are described in detail in the user documentation.

Table 9 lists the module’s services that can be performed without authentication.

Service	Access Type (R, W, Z)	Usage/Notes
Show Status	R	Displays system status information over LCD screen (e.g. network info, system operational status, etc.).
Self-Tests	R	When the BIG-IP system has been started, the Self-Tests are performed. This includes the integrity check and Known Answer Tests. On-Demand self-tests are initiated by manually power cycling the system.

Table 9 – Non-Authenticated Services

Table 10 lists the Management Services which are only available after authentication has succeeded. Use of any of the following services using non-approved algorithms will place the module in non-approved mode.

Service	Description	Access Type (Read (R) /Write (W)/ Zeroize (Z))	Keys and CSP	Authorization	
				Crypto Officer	User
User Management Services					
List Users	Display list of users	R	None	✓	User Manager Resource Manager
Create User	Create additional users	W	None	✓	User Manager
View Users	View users	R	None	✓	User Manager
Delete User	Delete users from module	W	None	✓	User Manager
Unlock User	Remove Lock from user who has exceeded login attempts	W, R	None	✓	User Manager
Update own password	Update own password	W	User Password	All Roles	

Service	Description	Access Type (Read (R) /Write (W)/ Zeroize (Z))	Keys and CSP	Authorization	
				Crypto Officer	User
Update others password	Update password for user that is not self	W	User Password	✓	User Manager
Configure Password Policy	Set password policy features	W	None	✓	None
Certificate Management Services					
Create SSL Certificate	Generate a self-signed certificate	W	TLS RSA/ECDSA Key Pair, DRBG V and Key values	✓	Certificate Manager
Create SSL Key	Generate SSL Certificate key file	W	TLS RSA/ECDSA Key Pair, DRBG V and Key values	✓	Certificate Manager
Check-Cert	Examines certificate and display or logs expiration date of installed certificates	R, W	None	✓	Certificate Manager
List Certificates	Display certificates installed	R	None	✓	Certificate Manager
Import SSL Certificate	Import SSL certificate into module	R	None	✓	Certificate Manager
Delete SSL Certificate	Delete a certificate from the module.	Z	None	✓	Certificate Manager
Export Certificate File	Export SSL certificate into module	W	None	✓	Certificate Manager
ssh-keyswap utility service	Use ssh-keyswap utility to create or delete ssh keys	R, W	SSH RSA/ECDSA Key Pair	✓	Certificate Manager
Firewall Management Services					
Configure firewall settings	Configure firewall policy rules, and address-lists for use by firewall rules.	R, W	None	✓	Firewall Manager
Show firewall state	Display the current system-wide state of firewall rules	R	None	✓	Firewall Manager
Show statistics	Displays statistics of firewall rules on the BIG-IP system	R	None	✓	Firewall Manager
Audit Management Services					

Service	Description	Access Type (Read (R) /Write (W)/ Zeroize (Z))	Keys and CSP	Authorization	
				Crypto Officer	User
View System Audit Logs	Display various service logs	R	None	✓	Auditor
Export Analytics Logs	Export system analytics logs	W	None	✓	Auditor
Enable/Disable audition	Enables/Disables system auditing	R	None	✓	Auditor
System Management Services					
Configure Boot Options	Enable Quit boot, manage boot locations	R, W	None	✓	Resource Manager
Configure SSH access options	Enable/Disable SSH access, Configure IP address whitelist	R, W	None	✓	Resource Manager
	Update private key	R, W	SSH RSA/ ECDSA Key Pair	✓	User Manager Resource Manager
Configure Firewall Users	Manage firewall rules	R, W	None	✓	Firewall Manager
Configure nodes and pool members	Enable/Disable nodes and pool members	R, W	None	✓	Operator
Configure iRules	create, modify, view, and delete iRules	R, W	None	✓	iRule Manager
Reboot System	Restart cryptographic module	W, Z	None	✓	Resource Manager
Secure Erase	Full system zeroization	W, Z	All CSPs	✓	None

Table 10 - Management Services

Table 11 lists the crypto services available in FIPS mode of operation, the roles that can request the service, the algorithms involved, the CSPs involved and how they are accessed.

Service	Algorithms / Key Sizes	Role	Keys/CSPs	Interface	
TLS Services				Data Plane	Control Plane
Establish TLS session	Signature Generation and Verification: RSA or ECDSA with SHA-256/SHA-384	User CO	RSA, ECDSA key pairs	Yes	Yes
	Key Exchange: RSA Key wrapping (allowed)		RSA, TLS pre-master secret and master secret	Yes	Yes
Maintaining TLS session	Data Encryption: AES CBC, GCM Data Authentication: HMAC SHA-1/SHA-256/SHA-384	User CO	AES and HMAC Keys	Yes	Yes
Closing TLS session	N/A	User CO	Session keys, secret	Yes	Yes

Table 11 - Crypto Services in FIPS mode of operation

Table 12 lists all of the non-approved services available in the non-FIPS-Approved mode of operation.

Service	Role	Usage/Notes
TLS Services		
Establishing TLS session	User CO	Signature generation and verification using DSA or RSA/ECDSA with SHA-1/SHA-224/SHA-512 RSA with keys less than 2048
		Key Exchange using: Diffie-Hellman ECDH shared secret computation with SP800-135 KDF RSA Key wrapping with keys less than 2048
Maintain TLS session		Data encryption using Triple-DES, AES-CTR, AES-GCM Data authentication using HMAC SHA-224/SHA-512
SSH Services		

Service	Role	Usage/Notes
Establish SSH session	User CO	Signature generation and verification using: DSA, Ed25519 ECDSA with SHA-1/SHA-224/ SHA-256/ SHA-384 /SHA-512 and all P-curves RSA with key size less than 2048-bit and 2048/ 3072-bits key sizes (SHA-1 and SHA-2) Key exchange using ECDH shared secret computation Diffie-Hellman, Ed25519 Key derivation SP800-135 SSH KDF
Maintain SSH session		Data encryption using Triple-DES, AES-CBC Data authentication using HMAC SHA-1/SHA-224/ SHA-256/ SHA-384/ SHA-512
Other Services		
IPsec	User CO	The configuration and usage of IPsec is not approved
iControl REST access		Access to the system through REST using non-approved crypto from BouncyCastle
Configuration using SNMP		Management of the module via SNMP is not approved.

Table 12 - Services in non-FIPS mode of operation

4 Physical Security

All of the modules listed in *Table 1: Tested Modules* are enclosed in a hard-metallic production grade case that provides obscurity from visual inspection of internal components. Each module is fitted with tamper evident labels to provide physical evidence of attempts to gain access inside the case. The tamper evident labels shall be installed for the module to operate in approved mode of operation. The Crypto Officer is responsible for inspecting the quality of the tamper labels on a regular basis to confirm the modules have not been tampered with. In the event that the tamper evident labels require replacement, a kit providing 25 tamper labels is available for purchase (P/N: F5-ADD-BIG-FIPS140). The Crypto Officer shall be responsible for the storage of the label kits.

Physical Security Mechanism	Recommended Inspection Frequency	Guidance
Tamper Evident Labels	Once per month	Check the quality of the tamper evident labels for any sign of removal, replacement, tearing, etc. If any label is found to be damaged or missing, contact the system administrator immediately.

Table 13 - Inspection of Tamper Evident Labels

4.1 Tamper Label Placement

The details below show the location of all tamper evident labels for each hardware appliances. Label application instructions are provided in the *F5 Platforms: FIPS Kit Installation* guide delivered with each hardware appliances.

Hardware Appliance	# of Tamper Labels	Hardware Appliance	# of Tamper Labels
BIG-IP i4000	3	BIG-IP i15800	5
BIG-IP i5000	3	BIG-IP 5250v-F	4
BIG-IP i5820-DF	4	BIG-IP 7200v-F	5
BIG-IP i7000	6	BIG-IP 10200v-F	4
BIG-IP i7820-DF	4	BIG-IP 10350v-F	4
BIG-IP i10800	6	VIPRION B2250	6
BIG-IP i11800-DS	6	VIPRION B4450	5

Table 14 - Number of Tamper Evident Labels per hardware appliance



Figure 13 - BIG-IP i4000 (3 of 3 tamper labels)

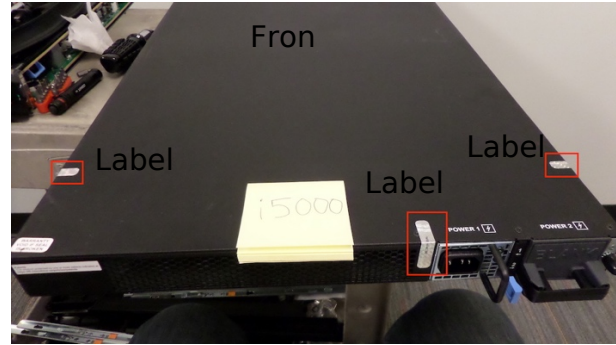

Figure 14 - BIG-IP i5000 (3 of 3 tamper labels)

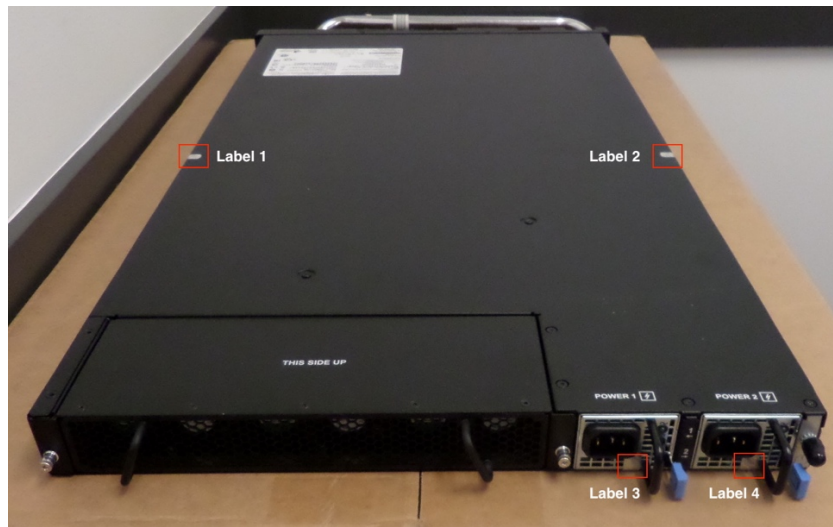

Figure 15 - BIG-IP i5820-DF (4 tamper labels shown)

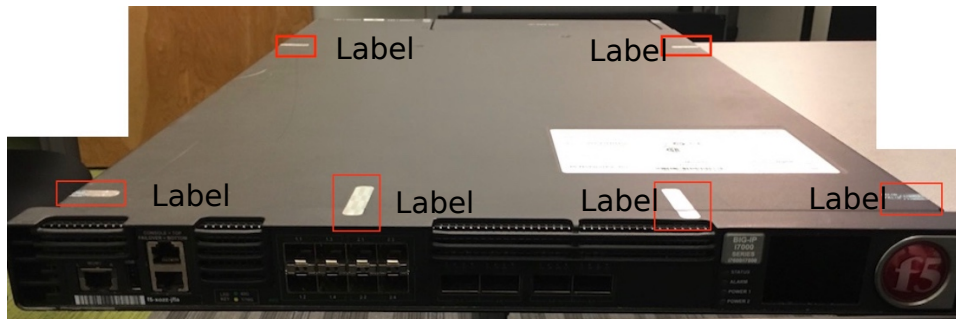

Figure 16 - BIG-IP i7000 (6 of 6 tamper labels shown)



Figure 17 - BIG-IP i7820-DF (4 tamper labels shown)

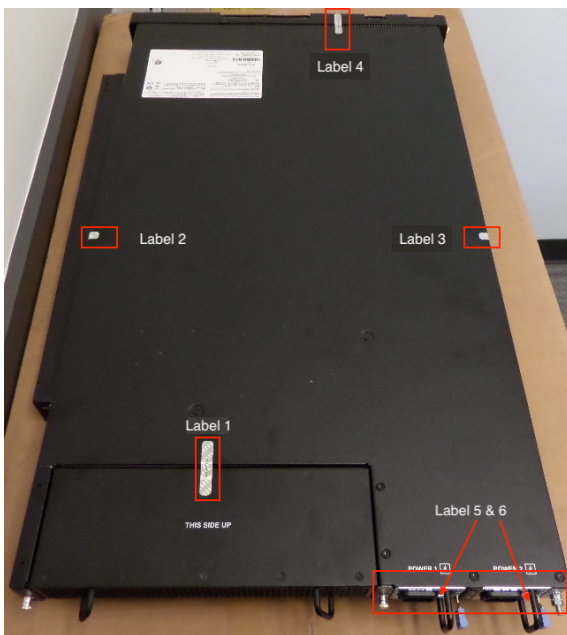

Figure 18 - BIG-IP i10800 / i11800-DS (6 tamper labels shown)



Figure 19 - BIG-IP i10800 / i11800-DS (tamper label 5 & 6)

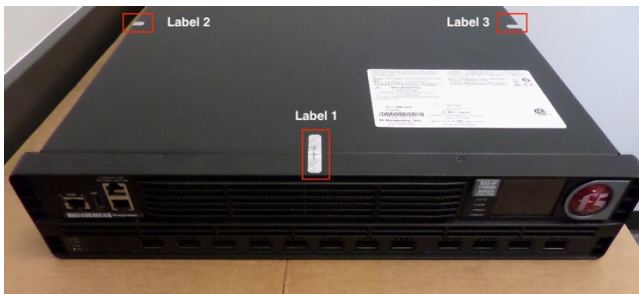

Figure 20 - BIG-IP i15800 (Front tamper labels 1-3 labels shown)

Figure 21 - BIG-IP i15800 (Back tamper labels 4 and 5 labels shown)



Figure 22 - BIG-IP 5250v-F (4 tamper labels shown)

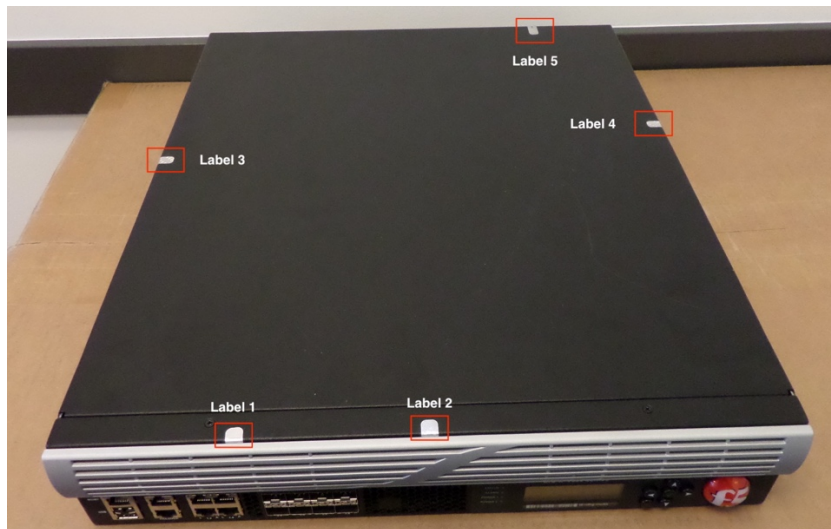

Figure 23 - BIG-IP 7200v-F (5 tamper labels shown)



Figure 24 - BIG-IP 10200v-F (Front tamper labels 1-3 shown)

Figure 25 - BIG-IP 10200v-F (Back tamper label 4 shown)



Figure 26 - VIPRION B2250 in chassis (1 of 6 tamper labels shown)

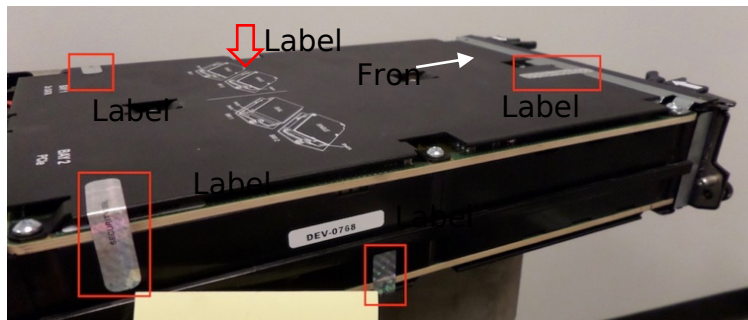

Figure 27 - VIPRION B2250 top view (5 of 6 tamper labels shown)



Figure 28 - VIPRION B4450 in chassis



Figure 29 - VIPRION B4450 front (1 of 5 tamper labels shown)

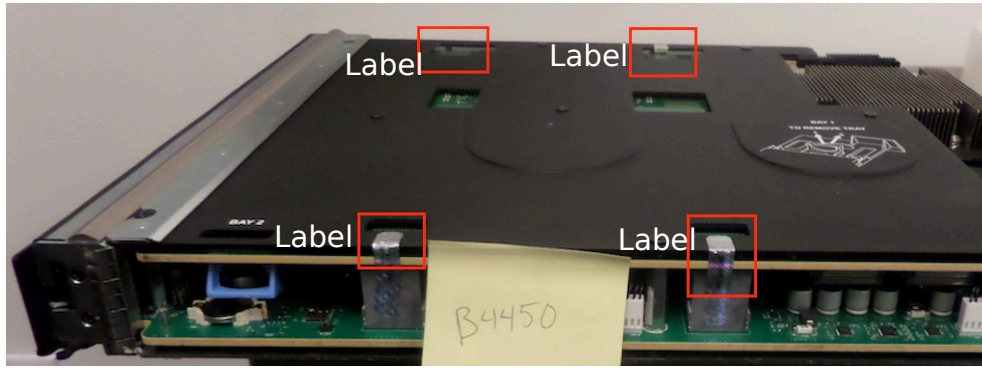

Figure 30 - VIPRION B4450 top-view (4 of 5 tamper labels shown)

5 Operational Environment

The module operates in a non-modifiable operational environment per FIPS 140-2 level 2 specifications and as such the operational environment requirements do not apply.

6 Cryptographic Key Management

The following table summarizes the CSPs that are used by the cryptographic services implemented in the module. Table 11 lists the services and the corresponding CSPs used in each service. Table 10 provides a list of services for the management of the module where, CSPs involved in User Management Services include user password.

Name	Generation	Storage	Zeroization
DRBG entropy input string	Obtained from NDRNG.	RAM	Zeroized by device reboot
DRBG V and Key values	Derived from entropy string as defined by [SP800-90A]	RAM	
TLS RSA private key	Generated using FIPS 186-4 Key generation method and the random value used in the key generation is generated using SP800-90A DRBG.	Disk	Zeroized when key file is deleted or by secure erase option at boot.
TLS RSA public key			
TLS ECDSA private key			
TLS ECDSA public key			
TLS Pre-Master Secret and Master Secret	Established during the TLS handshake	RAM	Zeroized by closing TLS session or by or rebooting the device.
Derived TLS session key (AES, HMAC)	Derived from the master secret via SP800-135 TLS KDF		
User Password	Entered by the user	Disk	Zeroized by secure erase option at boot or overwritten when password is changed

Table 15 - Life cycle of CSPs

The following sections describe how CSPs, in particular cryptographic keys, are managed during its life cycle.

6.1 Key Generation

For generation of RSA and ECDSA keys, the module implements asymmetric key generation services compliant with [FIPS186-4] and using DRBG compliant with [SP800-90A]. A seed (i.e. the random value) used in asymmetric key generation is obtained from [SP800-90A] DRBG.

The module does not implement symmetric key generation as an explicit service. The symmetric keys used by the module are derived from shared secret by applying SP 800-135 as part of the TLS protocol (section 6.2 SP 800-133r2).

In accordance with FIPS 140-2 IG D.12, the cryptographic module performs Cryptographic Key Generation (CKG) for the seed used in the generation of asymmetric keys as per SP800-133 (vendor affirmed).

6.2 Key Establishment

The module provides RSA Key wrapping scheme which is used as part of TLS protocol with the key derivation implemented by SP 800-135 TLS KDF. The module also includes a

SP 800-38F key wrapping in the context of TLS protocol where a key may be within a packet or message that is encrypted and authenticated using approved authenticated encryption mode i.e. AES GCM or a combination method which includes approved symmetric encryption algorithm i.e. AES together with approved authentication method i.e. HMAC-SHA. These schemes provide the following security strength in FIPS mode:

- RSA key wrapping provides between 112 or 128-bits of encryption strength
- SP 800-38F key wrapping using approved authenticated encryption mode i.e. AES GCM provides between 128 and 256 bits of encryption strength
- SP 800-38F key wrapping using a combination of approved AES encryption and HMAC authentication method provides between 128 and 256 bits of encryption strength
- SP 800-38F key wrapping using approved authenticated encryption mode i.e. AES GCM provides 128 or 256 bits of encryption strength
- SP 800-38F key wrapping using a combination of approved AES encryption and HMAC authentication method provides 128 or 256 bits of encryption strength

6.3 Key Entry / Output

The module does not support manual key entry or intermediate key generation key output. During the TLS handshake, the keys that are entered or output to the module over the network, includes RSA/ECDSA public keys and the TLS pre-master secret encrypted with RSA key only when using the RSA key exchange with TLS.

For TLS with RSA key exchange, when module acts as a TLS client, the TLS pre-master secret is generated using DRBG and is output from the module wrapped with server's public RSA key. When module acts as a TLS server, the TLS pre-master secret encrypted with module's RSA key is input into the module.

Once the TLS session is established, any key or data transfer performed thereafter is protected by AES encryption.

6.4 Key / CSP Storage

As shown in the above table most of the keys are stored in the non-volatile memory in plaintext form and are destroyed when released by the appropriate zeroization calls or the system is rebooted. The keys stored in plaintext in non-volatile memory are static and will remain on the system across power cycle and are only accessible to the authenticated administrator.

6.5 Key / CSP Zeroization

The zeroization methods listed in the above Table, overwrites the memory occupied by keys with "zeros". Additionally, the user can enforce it by performing procedural zeroization. For keys present in volatile memory, calling reboot command will clear the RAM memory. For keys present in non-volatile memory, using secure erase option (can only be triggered by the administrator during reboot of the device) will perform single pass zero write erasing the disk contents.

6.6 Random Number Generation

The module employs a Deterministic Random Bit Generator (DRBG) based on [SP800-90A] for the generation of random value used in asymmetric keys, and for providing an RNG service to calling applications. The Approved DRBG provided by the module is the CTR_DRBG with AES-256. The DRBG is initialized during module initialization. The module performs the health tests for the SP800-90A DRBG as defined per section 11.3 of SP800-90A.

The module uses a Non-Deterministic Random Number Generator (NDRNG) to seed the DRBG. A Continuous Random Number Generation Test (CRNGT) is performed on the output of the NDRNG prior to seeding the DRBG and also on the DRBG output. The NDRNG provides at least 256- bits of entropy to the DRBG during initialization (seed) and reseeding (reseed). The NDRNG is within its physical boundary.

7 Self-Tests

7.1 Power-Up Tests

The module performs power-up tests automatically during initialization when the device is booted without requiring any operator intervention; power-up tests ensure that the module’s firmware is not corrupted and that the cryptographic algorithms work as expected.

During the execution of power-up tests, services are not available and input and output are inhibited. Upon successful completion of the power-up tests, the module is initialized and enters operational mode where it is accessible for use. If the module fails any of the power-up tests, it enters into the ‘Halt Error’ state and halts the system. In this state, the module will prohibit any data outputs and cryptographic operations and will not be available for use. The module will be marked unusable and the administrator will need to reinstall the module to continue.

7.1.1 Integrity Tests

The integrity of the module is verified by comparing the MD5 checksum value of the installed binaries calculated at run time with the stored value computed at build time. If the values do not match the system enters halt error state and the device will not be accessible. In order to recover from this state, the module needs to be reinstalled.

7.1.2 Cryptographic algorithm tests

The module performs self-tests on all FIPS-Approved cryptographic algorithms supported in the approved mode of operation and is done on the Data Plane as well as Control Plane side, using the Known Answer Test (KAT) and Pair-wise Consistency Test (PCT) as listed in the following table:

Algorithm ⁸	Test
• Control Plane Self-tests	
CTR_DRBG	KAT using AES 256-bit with and without derivation function
AES	KAT of AES encryption with GCM mode and 128-bit key KAT of AES encryption/decryption ⁹ with ECB mode and 128-bit key
RSA	KAT of RSA PKCS#1 v1.5 signature generation with 2048 bit key and SHA-256 KAT of RSA PKCS#1 v1.5 signature verification with 2048 bit key and SHA-256
ECDSA	PCT of ECDSA signature generation and verification with P-256 curve

⁸ The module also includes KATs for ECDH shared secret computation but it is a non-approved algorithm hence it is not listed in this table.

⁹ Encryption and Decryption known answer tests are performed separately

Algorithm ⁸	Test
HMAC-SHA-1, HMAC-SHA-256, HMAC-SHA-384	KAT of HMAC-SHA-1 KAT of HMAC-SHA-256 KAT of HMAC-SHA-384
SHA-1, SHA-256, SHA-384	Covered by respective HMAC KATs
• Data Plane Self-Tests	
AES	KAT of AES encryption with GCM mode and 128-bit key KAT of AES decryption with CBC mode and 128-bit key
RSA	KAT of RSA PKCS#1 v1.5 signature generation with 2048 bit key and SHA-256 KAT of RSA PKCS#1 v1.5 signature verification with 2048 bit key and SHA-256
ECDSA	PCT of ECDSA signature generation and verification with P-256 curve
CTR_DRBG	Covered by Control Plane Self-Tests. (Data Plane makes use of the same DRBG implementation provided by Control Plane)
HMAC-SHA-1, HMAC-SHA-256, HMAC-SHA-384	KAT of HMAC-SHA-1 KAT of HMAC-SHA-256 KAT of HMAC-SHA-384
SHA-1, SHA-256, SHA-384	Covered by respective HMAC KATs

Table 16 – Self-Tests

7.2 On-Demand self-tests

The module does not explicitly provide the Self-Test service to perform on demand self-tests. On demand self-tests can be invoked by powering-off and powering-on the system in order to initiate the same cryptographic algorithm tests executed during power-up. During the execution of the on-demand self-tests, crypto services are not available and no data output or input is possible.

7.3 Conditional Tests

The module performs conditional tests on the cryptographic algorithms shown in the following table. If the module fails any of these tests, the device reboots and enters into the Halt Error state prohibiting any data output or cryptographic operations and the module will be inoperable. The module must be re-installed in order to clear the error condition.

Algorithm	Test
DRBG	CRNGT on the output of the DRBG
NDRNG	CRNGT on the output of the NDRNG prior to seeding the CTR_DRBG
RSA key generation	PCT using SHA-256
ECDSA key generation	PCT using SHA-256

Table 17 - Conditional Tests

8 Guidance

8.1 Delivery and Operation

The module is distributed as a part of a BIG-IP product which includes the hardware and an installed copy of 14.1.0.3 EHF. The hardware devices are shipped directly from the hardware manufacturer/authorized subcontractor via trusted carrier and tracked by that carrier. The hardware is shipped in a sealed box that includes a packing slip with a list of components inside, and with labels outside printed with the product nomenclature, sales order number, and product serial number. Upon receipt of the hardware, the customer is required to perform the following verifications:

- Ensure that the shipping label exactly identifies the correct customer name and address as well as the hardware model.
- Inspect the packaging for tampering or other issues.
- Ensure that the external labels match the expected delivery and the shipped product.
- Ensure that the components in the box match those on the documentation shipped with the product.
- The hardware model can be verified by the model number given on the shipping label as well as on the hardware device itself.

For FIPS compliance, the following steps defined in section 8.2 should be completed by the Crypto Officer prior to access to the device is allowed.

8.2 Crypto Officer Guidance

8.2.1 Installing Tamper Evident Labels

Before the device is installed in the production environment, tamper-evident labels must be installed in the location identified for each module in section 4.1. The following steps should be taken when installing or replacing the tamper evident labels on the module. The instructions are also included in *F5 Platforms: FIPS Kit Installation* provided with each module.

- Use the provided alcohol wipes to clean the chassis cover and components of dirt, grease, or oil before you apply the tamper evidence seals.
- After applying the seal, run your finger over the seal multiple times using extra high pressure.
- The seals completely cure within 24 hours.

It is the responsibility of the Crypto Officer to inspect the tamper evident labels for damage or any missing labels as specified in Section 4.

8.2.2 Install Device

- Follow the instructions in the "*BIG-IP System: Initial Configuration*" guide for the initial setup and configuration of the device.

- Add the FIPS license when prompted during the GUI setup wizard. Guidance on Licensing the BIG-IP system can be found in <https://support.f5.com/csp/article/K7752>.

8.2.3 Password Strength Requirement

The Crypto officer must modify the BIG-IP password policy to meet or exceed the requirements defined in Table 7 – Authentication of Roles. Instructions for this can be found in the “*BIG-IP System: User Account Administration*” guide. After assuming the role for the first time, the Crypto Officer shall replace the default password with one matching the password policy.

8.2.4 Additional Guidance

The Crypto Officer should verify that the following specific configuration rules are followed in order to operate the module in the FIPS validated configuration:

- All command shells other than tmsh are not allowed. For example, bash and other user-serviceable shells are excluded. Additionally note that the use of tmsh is considered non-approved because it makes use of SSH protocol that is marked as non-approved service in Table 12. Only access via GUI interface that makes use of TLS channel is considered approved.
- Management of the module via the appliance's LCD display is not allowed.
- Usage of f5-rest-node and iAppLX and provisioning of iRulesLX is not allowed.
- Only the provisioning of AFM and LTM is included.
- Remote access to the Lights Out / Always On Management capabilities of the system are not allowed.
- Serial port console should be disabled after the initial power on and communications setup of the hardware.
- On the i11800-DS device, the Cavium Nitrox-V must be disabled using `lspci | grep -i encryption | awk '{print "device exclude " $1;}' > tmm_init.tcl` command since full support is not available.

8.2.5 Version Configuration

Once the device is installed, licensed and configured, the Crypto Officer should confirm that the system is installed and licensed correctly.

8.2.5.1 Version Confirmation

The Crypto Officer should through the Big-IP Configuration Utility (Web interface) HTTPS access, navigate within the GUI to Main -> System -> Configuration -> Device -> General and verify the version shown with the approved version from Table 1 - Tested Modules. Any firmware loaded into the module other than version 14.1.0.3 EHF is out of the scope of this validation and will mean that the module is not operating as a FIPS validated module.

8.2.5.2 License Confirmation

The FIPS validated module activation requires installation of the license referred as 'FIPS license'. The Crypto Officer should through the Big-IP Configuration Utility (Web interface) HTTPS access, navigate within the GUI to Main -> System -> License and verify that the list of license flags includes the "FIPS 140-2 Compliant Mode".

8.3 User Guidance

The module supports two modes of operation. Table 11 - Crypto Services in FIPS mode of operation list the FIPS approved services and Table 12 - Services in non-FIPS mode of operation lists the non-FIPS approved services. Using the services in Table 5 - Non-Approved and Non-Compliant Cryptographic Algorithms/Modes means that the module operates in non-FIPS Approved mode for the particular session of a particular service, where the non-FIPS approved algorithm or mode was selected.

AES-GCM IV is constructed in accordance with SP800-38D in compliance with IG A.5 scenario 1. The implementation of the nonce_explicit management logic inside the module ensures that when the IV exhausts the maximum number of possible values for a given session key, the module triggers a new handshake request to establish a new key. In case the module's power is lost and then restored, the key used for the AES GCM encryption or decryption shall be re-distributed. The AES GCM IV generation is follows [RFC5288] and shall only be used for the TLS protocol version 1.2 to be compliant with [FIPS140-2_IG] IG A.5; thus, the module is compliant with [SP800-52].

9 Mitigation of Other Attacks

The module does not implement security mechanisms to mitigate other attacks.

Appendix A. Glossary and Abbreviations

AES	Advanced Encryption Standard
CBC	Cipher Block Chaining
CFB	Cipher Feedback
CSP	Critical Security Parameter
CTR	Counter Mode
CVL	Component Validation List
DES	Data Encryption Standard
DSA	Digital Signature Algorithm
DRBG	Deterministic Random Bit Generator
ECB	Electronic Code Book
ECC	Elliptic Curve Cryptography
FIPS	Federal Information Processing Standards Publication
GCM	Galois Counter Mode
HMAC	Hash Message Authentication Code
KAS	Key Agreement Scheme
KAT	Known Answer Test
MAC	Message Authentication Code
NIST	National Institute of Science and Technology
NDRNG	Non-Deterministic Random Number Generator
OFB	Output Feedback
RNG	Random Number Generator
RSA	Rivest, Shamir, Adleman
SHA	Secure Hash Algorithm
XTS	XEX-based Tweaked-codebook mode with cipher text stealing

Appendix B. References

- FIPS140-2 FIPS PUB 140-2 - Security Requirements For Cryptographic Modules
May 2001
<http://csrc.nist.gov/publications/fips/fips140-2/fips1402.pdf>
- FIPS140-2_IG Implementation Guidance for FIPS PUB 140-2 and the Cryptographic Module
Validation Program
May 2019
<http://csrc.nist.gov/groups/STM/cmvp/documents/fips140-2/FIPS1402IG.pdf>
- FIPS180-4 **Secure Hash Standard (SHS)**
March 2012
http://csrc.nist.gov/publications/fips/fips180-4/fips_180-4.pdf
- FIPS186-4 **Digital Signature Standard (DSS)**
July 2013
<http://nvlpubs.nist.gov/nistpubs/FIPS/NIST.FIPS.186-4.pdf>
- FIPS197 **Advanced Encryption Standard**
November 2001
<http://csrc.nist.gov/publications/fips/fips197/fips-197.pdf>
- FIPS198-1 **The Keyed Hash Message Authentication Code (HMAC)**
July 2008
http://csrc.nist.gov/publications/fips/fips198_1/FIPS-198_1_final.pdf
- PKCS#1 **Public Key Cryptography Standards (PKCS) #1: RSA Cryptography**
Specifications Version 2.1
February 2003
<http://www.ietf.org/rfc/rfc3447.txt>
- SP800-38A NIST Special Publication 800-38A - Recommendation for Block Cipher Modes of
Operation Methods and Techniques
December 2001
<http://csrc.nist.gov/publications/nistpubs/800-38a/sp800-38a.pdf>
- SP800-38D NIST Special Publication 800-38D - Recommendation for Block Cipher Modes of
Operation: Galois/Counter Mode (GCM) and GMAC
November 2007
<http://csrc.nist.gov/publications/nistpubs/800-38D/SP-800-38D.pdf>
- SP800-56A NIST Special Publication 800-56A - Recommendation for Pair-Wise Key
Establishment Schemes Using Discrete Logarithm Cryptography (Revised)
March 2007
http://csrc.nist.gov/publications/nistpubs/800-56A/SP800-56A_Revision1_Mar08-2007.pdf
- SP800-90A NIST Special Publication 800-90A - Recommendation for Random Number
Generation Using Deterministic Random Bit Generators
January 2012
<http://csrc.nist.gov/publications/nistpubs/800-90A/SP800-90A.pdf>

SP800-131A NIST Special Publication 800-131A - Transitions: Recommendation for
Transitioning the Use of Cryptographic Algorithms and Key Lengths
November 2015
<http://nvlpubs.nist.gov/nistpubs/SpecialPublications/NIST.SP.800-131Ar1.pdf>